

Quick Reference Guide Upright Vacuum Cleaner Guide de référence Aspirateur vertical

To prevent accidents and machine damage, read the attached operating instructions before installation and use.

Afin de prévenir les accidents et d'éviter d'endommager l'appareil, veuillez lire attentivement les instructions d'utilisation ci-jointes avant de l'installer ou de l'utiliser.

en, fr - US, CA

The illustrations referred to can be found on the following pages.

Using the vacuum cleaner

Assembling the vacuum cleaner (see fig. 1)

If your vacuum cleaner is equipped with an exhaust filter Active AirClean or HEPA AirClean, you will need to activate the exhaust filter change indicator (see Operating Instructions, page 9).

Releasing / Rewinding the power cord (see fig. 2)

Align cord with notch (see fig. 3)

Releasing the body of the vacuum cleaner (see fig. 4)

Turning the vacuum cleaner On/Off (see fig. 5)

Selecting the flooring type (see fig. 6 + 7)

Securing the vacuum hose and wand (see fig. 8)

Telescopic wand (see fig. 9 + 10)

Turning the Powerbrush On/Off (see fig. 11)

Included accessories (see fig. 12)

Lifting the vacuum head (see fig. 13)

Maintenance

Airflow indicator (see fig. 14)

Opening the dust compartment (see fig. 15)

Removing the FilterBag (see fig. 16)

Inserting the FilterBag (see fig. 17)

Please see the Operating Instructions for more information on how to change the FilterBag and exhaust filter.

Vous trouverez les croquis à la fin de ce guide de référence.

Utilisation de l'aspirateur

Assemblage de l'aspirateur (voir fig. 1)

Dérouler/Enrouler le cordon d'alimentation (voir fig. 2)

Aligner le cordon avec le cran (voir fig. 3)

Retirer le boîtier de l'aspirateur (voir fig. 4)

Mettre l'aspirateur en marche et l'éteindre (voir fig. 5)

Sélectionner le type de sol (voir fig. 6 + 7)

Ajuster le tuyau et le tube de l'aspirateur (voir fig. 8)

Tube télescopique (voir fig. 9 + 10)

Mettre l'électrobrosse en marche et l'éteindre (voir fig. 11)

Accessoires fournis (voir fig. 12)

Soulever la tête de l'aspirateur (voir fig. 13)

Entretien

Indicateur de circulation d'air (voir fig. 14)

Ouvrir le réservoir à poussière (voir fig. 15)

Enlever le sac à poussière (voir fig. 16)

Insertion du sac à poussière (voir fig. 17)

Lire attentivement les instructions d'utilisation pour savoir comment changer les filtres d'évacuation.

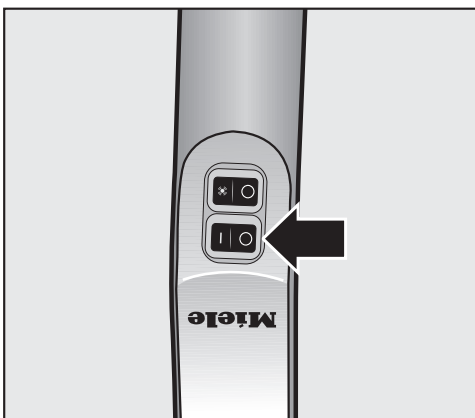
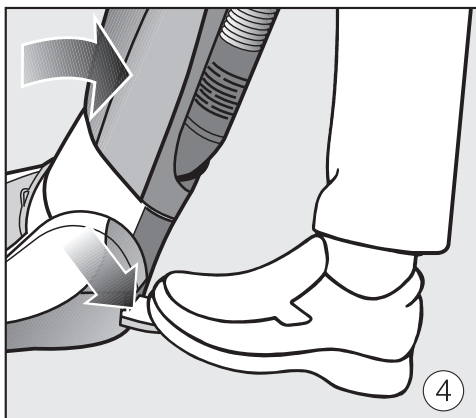
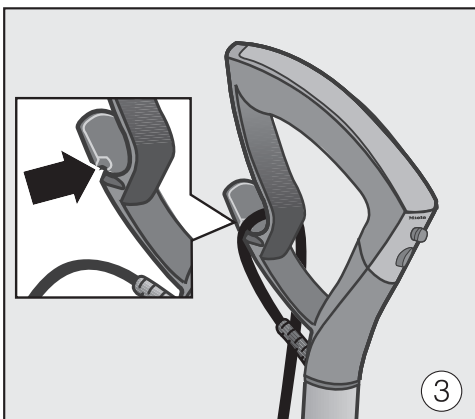
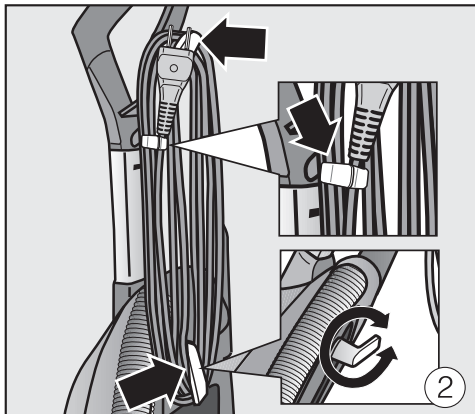
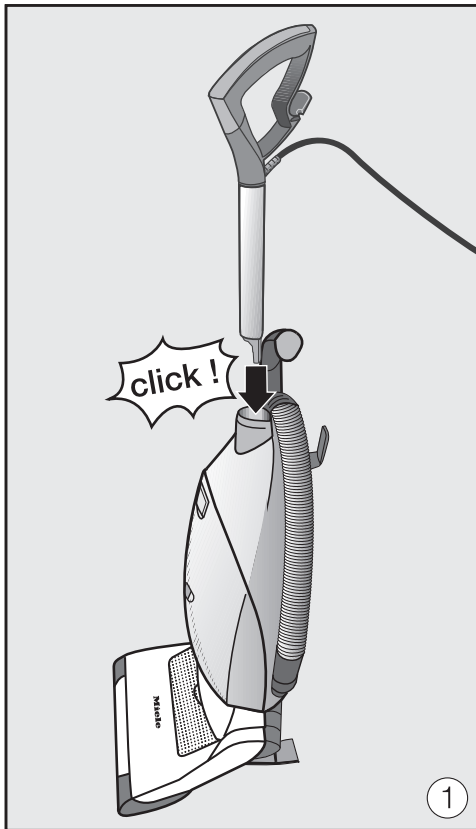

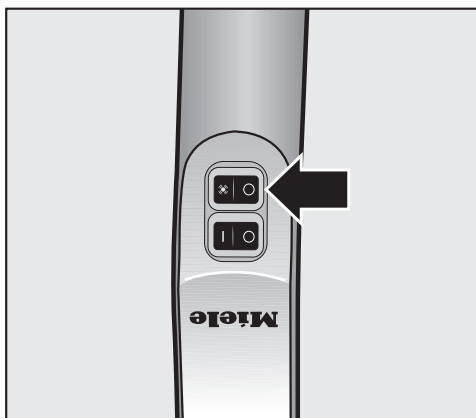
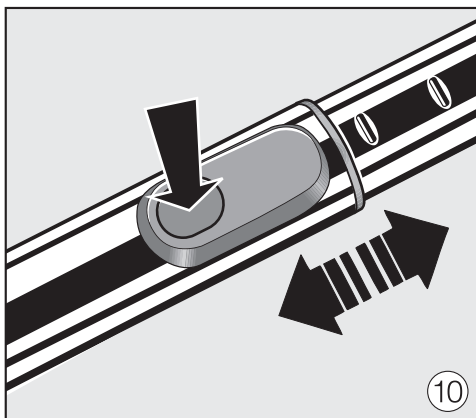
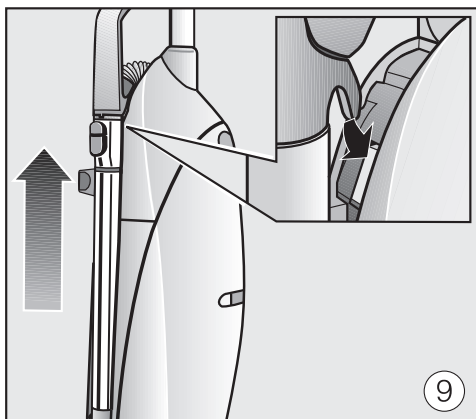
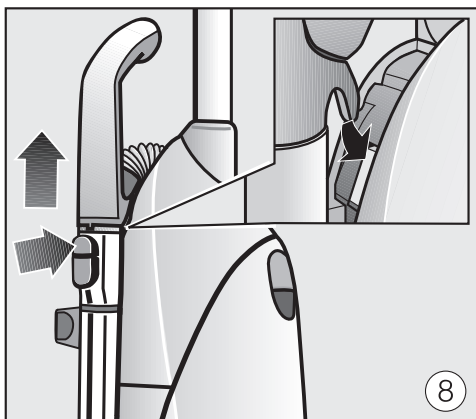
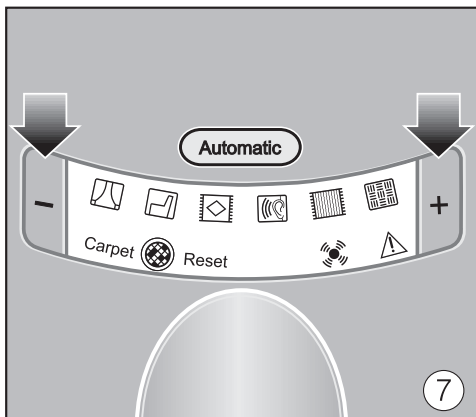
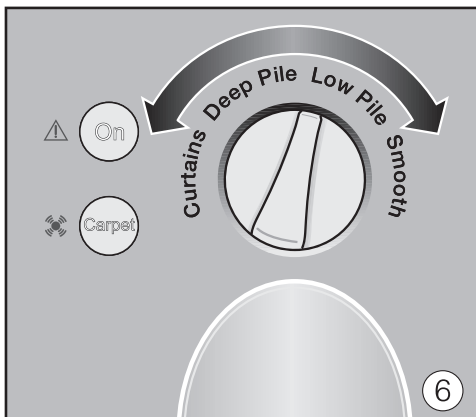

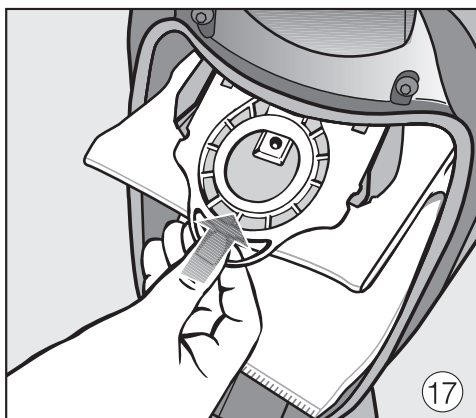
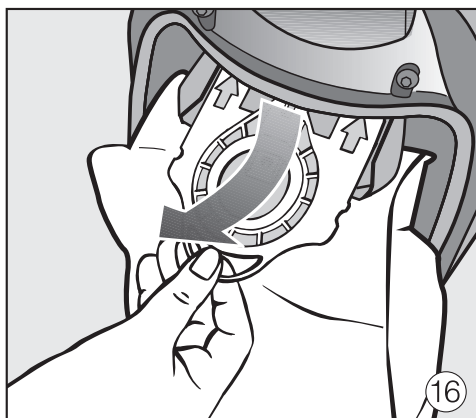
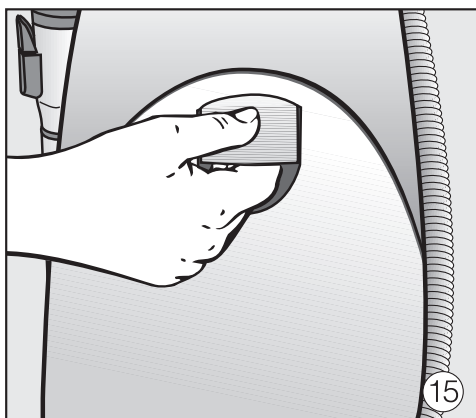
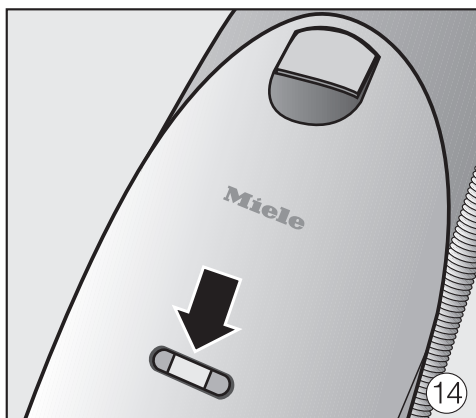
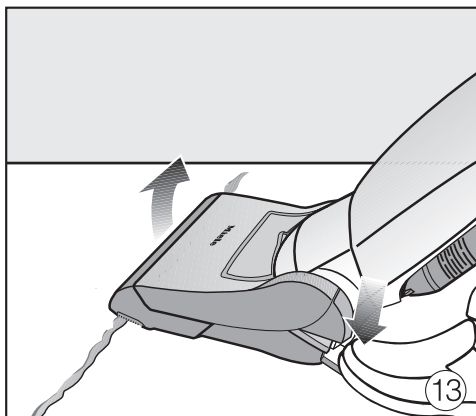



Canada
Importateur
Miele Limitée

Siège social au Canada et Centre Miele

161 Four Valley Drive
Vaughan, ON L4K 4V8
www.miele.ca

Service à la clientèle

Téléphone : 800-565-6435
customercare@miele.ca

Allemagne

Fabricant

Miele & Cie. KG
Carl-Miele-Straße 29
33332 Gütersloh



www.miele-shop.com

Please have the model and serial number
of your appliance available before
contacting Technical Service.

Miele

U.S.A.

Miele, Inc.

National Headquarters

9 Independence Way
Princeton, NJ 08540
Phone: 800-843-7231
609-419-9898
Fax: 609-419-4298
www.mieleusa.com

Technical Service & Support Nationwide

Phone: 800-999-1360
Fax: 888-586-8056
TechnicalService@mieleusa.com



Canada

**Importer
Miele Limited**

Headquarters and Miele Centre

161 Four Valley Drive
Vaughan, ON L4K 4V8
www.miele.ca

Customer Care Centre

Phone: 800-565-6435
905-532-2272
customercare@miele.ca

Germany

Manufacturer
Miele & Cie. KG
Carl-Miele-Straße 29
33332 Gütersloh